



MARQUE: MOULINEX

REFERENCE: AM480070

CODIC: 4017765

# Moulinex®

mega 2kg

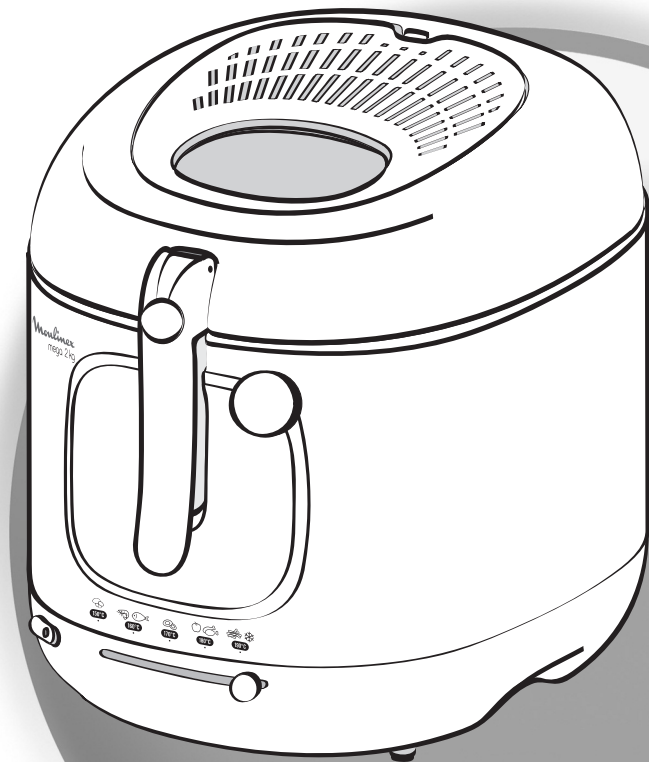

[www.moulinex.com](http://www.moulinex.com)

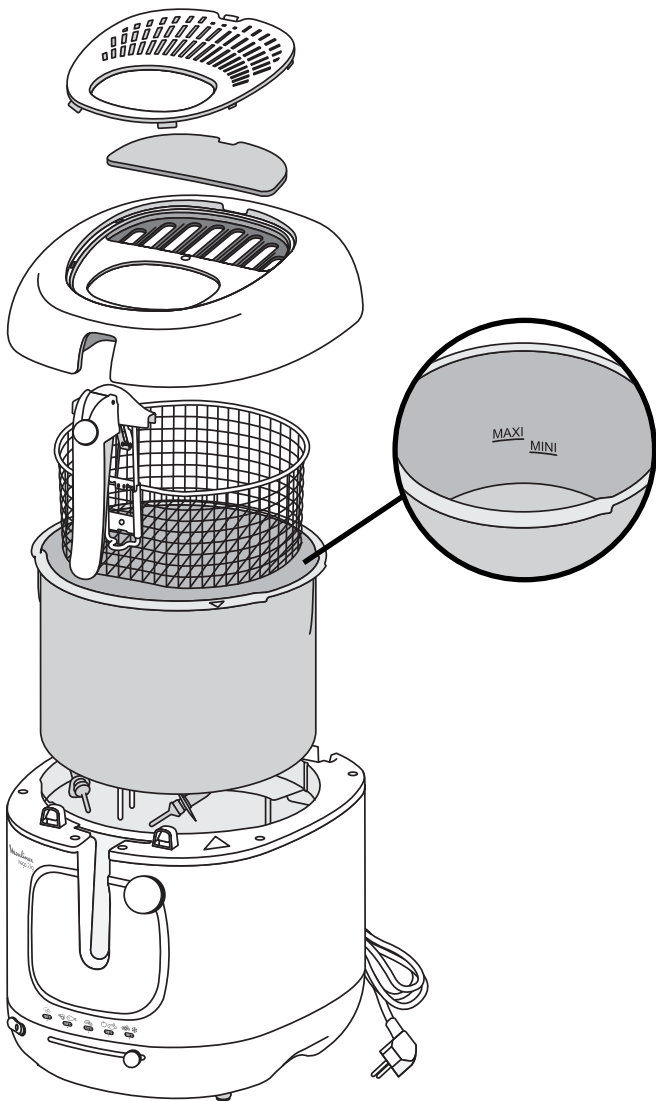

1

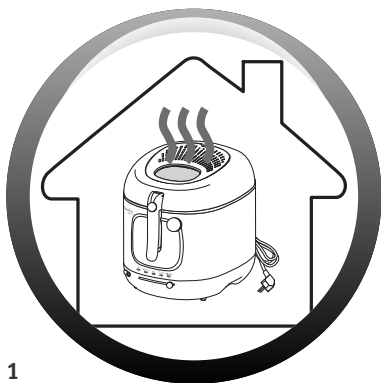

1

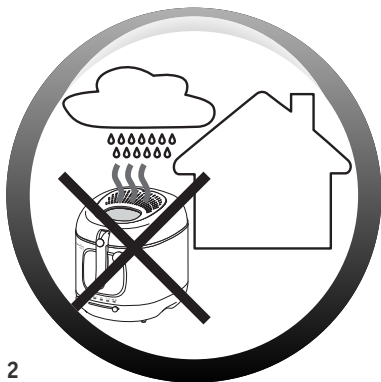

2

3

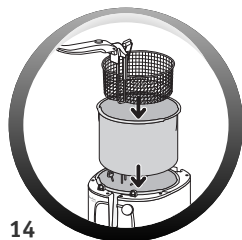
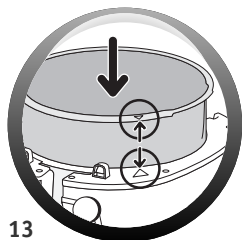
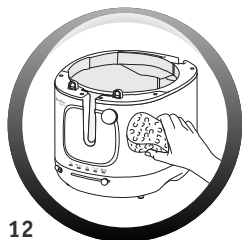
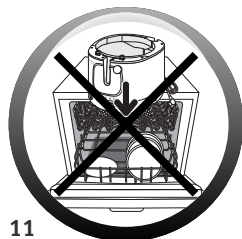
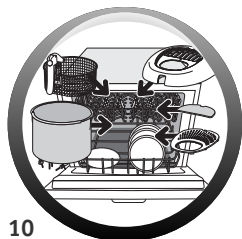
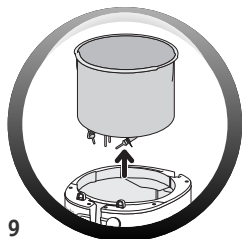
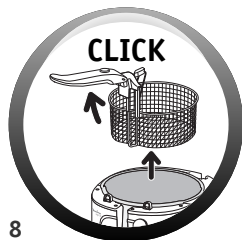
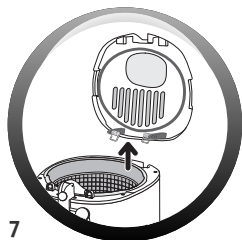
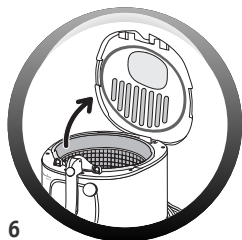
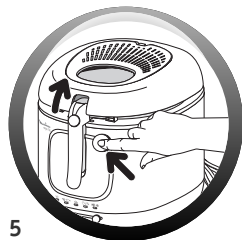
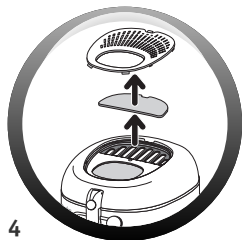
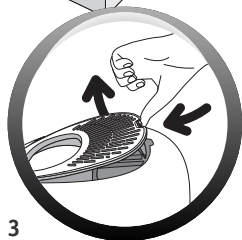

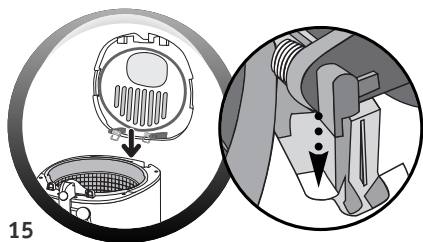

15

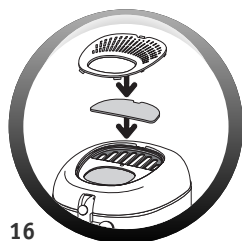

16



Mini = 3 L

Maxi = 3,3 L

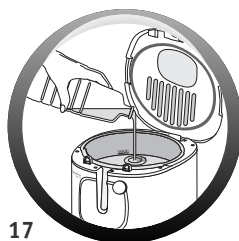

17

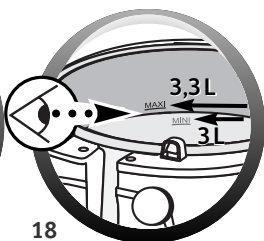

18

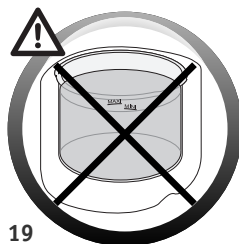

19

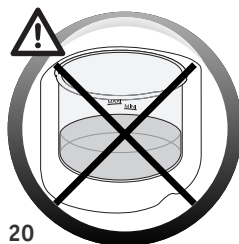

20

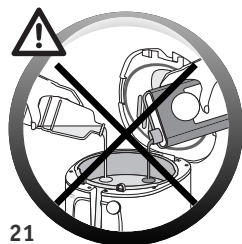

21

4

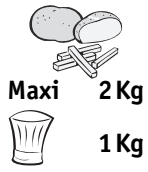

Maxi 2 Kg

1 Kg



22

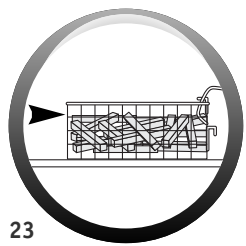

23



24



Maxi 1,5 Kg

750g



25

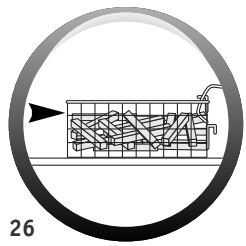

26



27



28

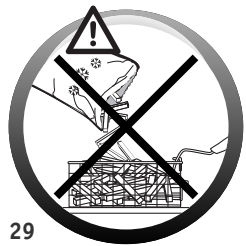

29

5

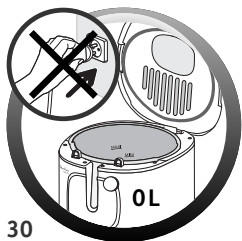

30

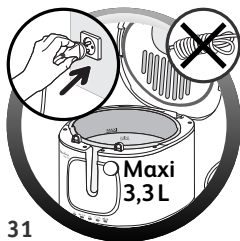

31

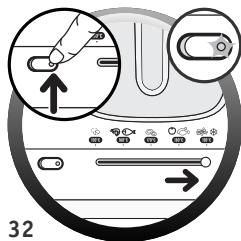

32

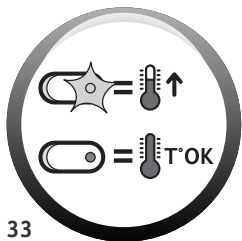

33

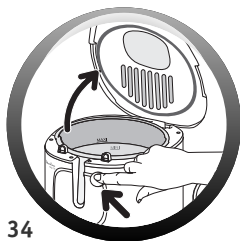

34

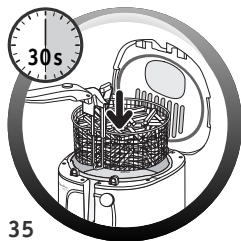

35

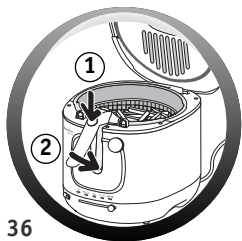

36

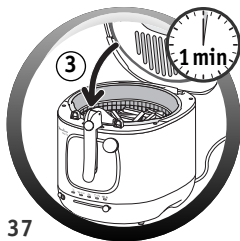

37

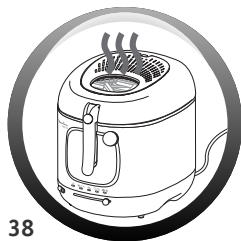































38



39





	Nb			
		2 Kg	190°C	+/- 19-25 min
		2 Kg	1 - 160°C 2 - 190°C	+/- 14-17 min +/- 9-11 min
		1 Kg	190°C	+/- 11-15 min
		1 Kg	170°C	+/-12-16 min
	8-10		190°C	+/- 9-10 min
	3/4		180°C	+/-12-19 min
	1-2		160°C	+/- 4-7 min
		300 g	150°C	+/- 4-6 min
	10-12		180°C	+/-11-13 min
	6		180°C	+/- 5-6 min
<b>* * *</b>	<b>Nb</b>			
		1,5 Kg	190°C	+/-13-19 min
		750 g	190°C	+/- 7-10 min
		750 g	170°C	+/- 8-11 min
		500 g	170°C	+/- 4-7 min
	10 p		190°C	+/- 5-7 min
		2 Kg	190°C	+/- 10-12 min
		300 g	190°C	+/- 3-5 min

7

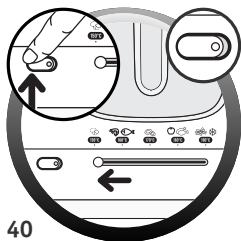

40

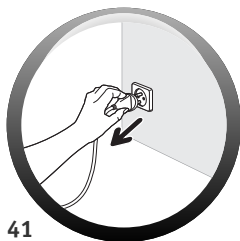

41



42

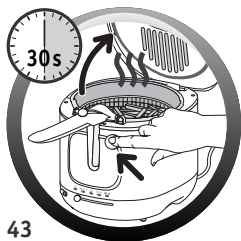

43

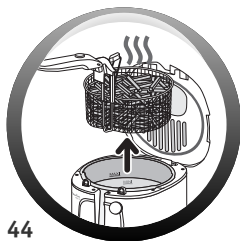

44

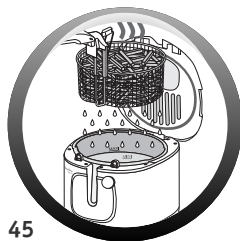

45



46

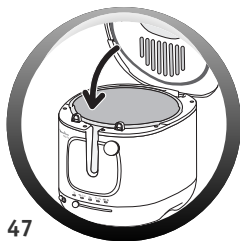

47



48

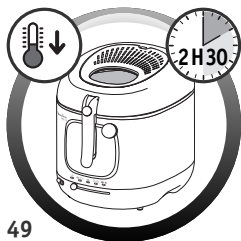

49

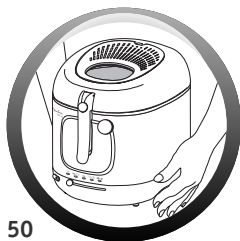

50

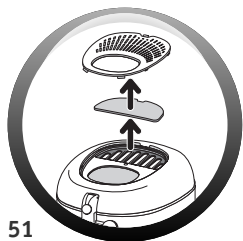

51

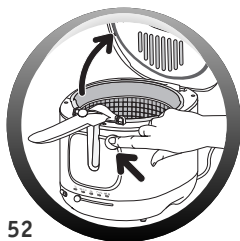

52

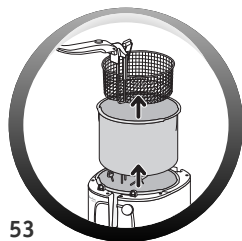

53

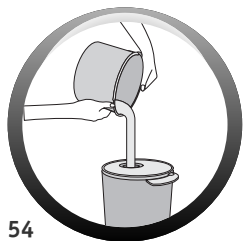

54

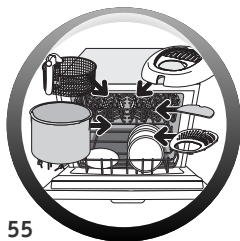

55

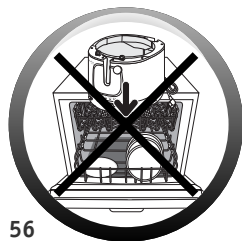

56

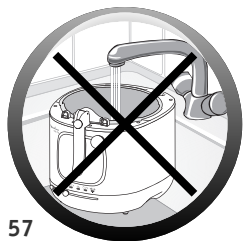

57

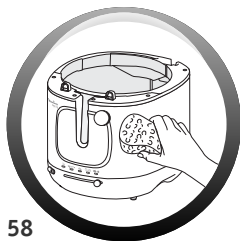

58

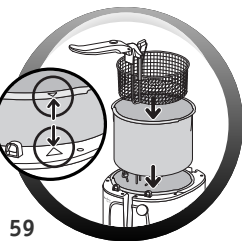

59

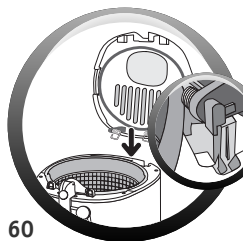

60

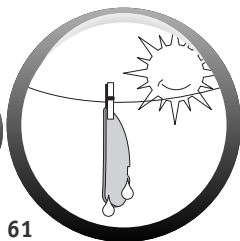

61

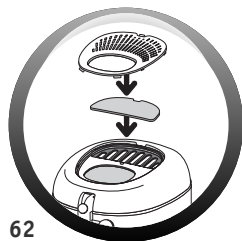

62

9

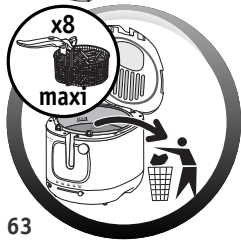

63

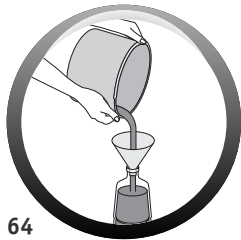

64

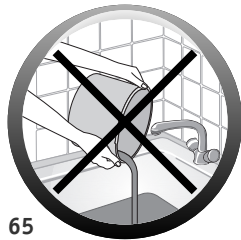

65



66



67

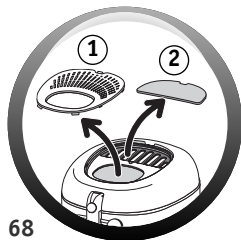

68



69

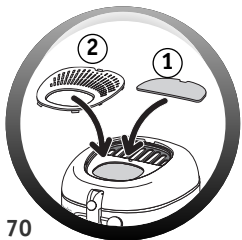

70



71



72



73

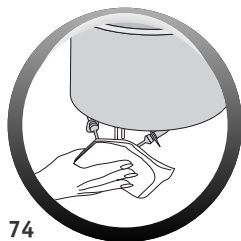

74

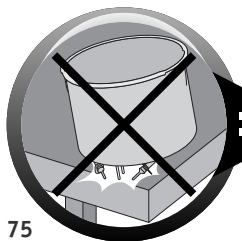

75

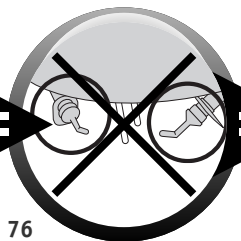

76

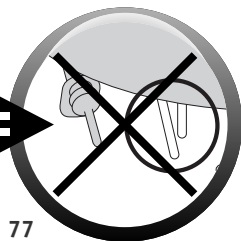

77

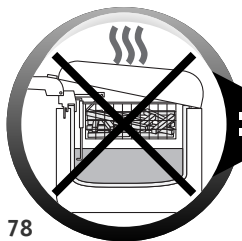

78

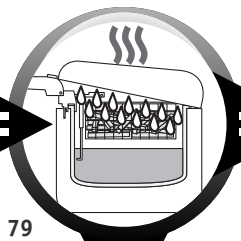

79

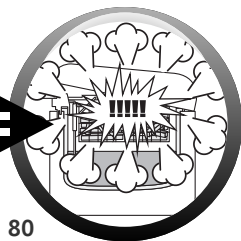

80



81

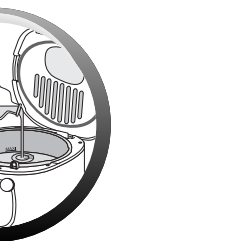
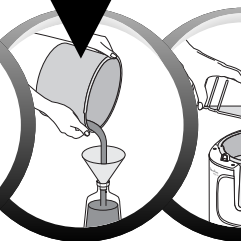

# INTERNATIONAL GUARANTEE : COUNTRY LIST

			
الجزائر ALGERIA	(0)41- 28 18 53	سنة واحدة 1 year	CIJA 9 rue Puvis de Chavannes - Saint Euquene Oran
ARGENTINA	0800-122-2732	2 años 2 years	GRUPE SEB ARGENTINA S.A. Billinghurst 1833 3°, C1425DTK Capital Federal - Buenos Aires
ՀԱՅԱՍՏԱՆ ARMENIA	(010) 55-76-07	2 տարի 2 years	ՓԲԸ "Գրուպպա ՄԵԲ", 125171, Մոսկվա, Լենինգրադայան խմբովի, 16A, շին.3
AUSTRALIA	02 97487944	2 years	GRUPE SEB AUSTRALIA PO Box 7535, Silverwater - NSW 2128
ÖSTERREICH AUSTRIA		2 Jahre 2 years	SEB ÖSTERREICH GmbH Campus 21 - Businesspark Wien Süd, Liebermannstr. A02 702 - 2345 Brunn am Gebirge
БЕЛАРУСЬ BELARUS	017 2239290	2 года 2 years	ЗАО «Група СЕБ-Восток», 125171, Москва, Ленинградское шоссе, д. 16А, стр. 3
BELGIQUE-BELGIE BELGIUM	070 23 31 59	2 ans 2 years	GRUPE SEB BELGIUM SA NV 25 avenue de l'Espérance - ZI - 6220 Fleurus
BOSNA I HERCEGOVINA	Info-linija za potrošače 033 551 220	2 godine 2 years	SEB Développement Predstavništvo u BiH - Vrazova 8/II 71000 Sarajevo
BRASIL BRAZIL	0800-119933	1 ano 1 year	SEB COMERCIAL DE PRODUTOS DOMÉSTICOS LTDA Rua Venância Aires, 433/437/447, Pompéia, São Paulo/SP
БЪЛГАРИЯ BULGARIA	0700 10 330	2 години 2 years	ГРУП СЕБ БЪЛГАРИЯ ЕООД бул. България 81 В, ет. 5 - 1404 София
CANADA	1-800-418-3325	1 an 1 year	GRUPE SEB CANADA 345 Passmore Avenue Toronto, ON - M1V 3N8
CHILE	12300 209207	2 años 2 years	GRUPE SEB CHILE Comercial Ltda Av. Providencia, 2331, piso 5, Oficina 501 - Santiago
COLOMBIA	18000919288	2 años 2 years	GRUPE SEB COLOMBIA Apartado Aereo 172, Kilometro 1 Via Zipaquirá - Cajica Cundinamarca
HRVATSKA CROATIA	01 30 15 294	2 godine 2 years	SEB Développement S.A.S. Vodnjanska 26, 10000 Zagreb
ČESKA REPUBLIK CZECH REPUBLIC	731 010 111	2 roky 2 years	GRUPE SEB ČR spol. s r. o. Jankovcova 1569/2c - 170 00 Praha 7
DANMARK DENMARK	44 663 155	2 år 2 years	GRUPE SEB NORDIC AS Tempovej 27 - 2750 Ballerup
EESTI ESTONIA	5 800 3777	2 aastat 2 years	GRUPE SEB POLSKA SP. z o.o. ul. Bukowińska 22b - 02-703 Warszawa
مصر EGYPT	16622 : الخط الساخن	سنة واحدة 1 year	جروب سب الجيبت طريق 14 مايو - سموحة الإسكندرية - مصر
SUOMI FINLAND	09 622 94 20	2 Vuotta 2 years	Groupe SEB Finland Kutojantie 7 - 02630 Espoo
FRANCE Continentale + Guadeloupe, Martinique, Réunion, Saint-Martin	09 74 50 10 14	1 an 1 year	GRUPE SEB FRANCE Service Consommateur Moulinex BP 15 - 69131 ECULLY CEDEX

			
<b>DEUTSCHLAND GERMANY</b>	<b>0212 387 400</b>	<b>2 Jahre</b> 2 years	GRUPE SEB DEUTSCHLAND GmbH KRUPS GmbH Herrnrainweg 5 - 63067 Offenbach
<b>ΕΛΛΑΔΑ GREECE</b>	<b>2106371251</b>	<b>2 χρόνια</b> 2 years	SEB GROUPE ΕΛΛΑΔΟΣ Α.Ε. Οδός Καβαλιεράτου 7 Τ.Κ. 145 64 Ν. Κηφισιά
<b>香港 HONG KONG</b>	<b>8130 8998</b>	<b>1 year</b>	SEB ASIA Ltd. Room 903, 9/F, South Block, Skyway House 3 Sham Mong Road, Tai Kok Tsui, Kowloon - Hong-Kong
<b>MAGYARORSZÁG HUNGARY</b>	<b>06 1 801 8434</b>	<b>2 év</b> 2 years	GRUPE SEB CENTRAL-EUROPE Kft. Táviró köz 4 - 2040 Budaörs
<b>INDONESIA</b>	<b>+62 21 5793 6881</b>	<b>1 year</b>	Groupe SEB Indonesia (Representative office) Sudirman Plaza, Plaza Marein 8th Floor JL Jendral Sudirman Kav 76-78, Jakarta 12910, Indonesia
<b>ITALIA ITALY</b>	<b>1 99 207 892</b>	<b>2 anni</b> 2 years	GRUPE SEB ITALIA S.p.A. Via Montefeltro, 4 - 20156 Milano
<b>日本 JAPAN</b>	<b>0570 077 772</b>	<b>1 year</b>	株式会社ブルーセブジャパン - 〒141-0022 東京都品川区東五反田3-14-13 高輪ミュージアムビル
<b>ҚАЗАҚСТАН KAZAKHSTAN</b>	<b>727 378 39 39</b>	<b>2 жыл</b> 2 years	ЖАҚ «Группа СЕБ- Восток» 125171, Мәскеу, Ленинградское шоссеі, 16А, 3 үйі
<b>한국어 KOREA</b>	<b>1588-1588</b>	<b>1 year</b>	(유)그림 세브 코리아 서울시 종로구 서린동 88 서린빌딩 - 3층, 110-790
<b>LATVIJA LATVIA</b>	<b>6 716 2007</b>	<b>2 gadi</b> 2 years	GRUPE SEB POLSKA Sp. z o.o. ul. Bukowińska 22b 02-703 Warszawa
<b>LIETUVA LITHUANIA</b>	<b>6 470 8888</b>	<b>2 years</b>	GRUPE SEB POLSKA Sp. z o.o. ul. Bukowińska 22b 02-703 Warszawa
<b>LUXEMBOURG</b>	<b>0032 70 23 31 59</b>	<b>2 ans</b> 2 years	GRUPE SEB BELGIUM SA NV 25 avenue de l'Espérance - ZI - 6220 Fleurus
<b>МАКЕДОНИЈА MACÉDONIA</b>	<b>(0)2 2050 022</b>	<b>2 години</b> 2years	Groupe SEB Bulgaria EOOD Office 1, floor 1, 52G Borovo St., 1680 Sofia - Bulgaria ГРУП СЕБ БЪЛГАРИЯ ДООЕЛ Ул. Борово 52 Г, сп. 1, офис 1, 1680 София - България
<b>MALAYSIA</b>	<b>603 7710 1175</b>	<b>1 year</b>	GRUPE SEB MALAYSIA SDN. BHD Unit No. 402-403, Level 4, Uptown 2, No. 2, Jalan SS21/37, Damansara Uptown, 47400, Petaling Jaya, Selangor D.E Malaysia
<b>MEXICO</b>	<b>(01800) 112 8325</b>	<b>1 año</b> 1 year	Groupe S.E.B. México, S.A. DE C.V. Goldsmith 38 Desp. 401, Col. Polanco Delegación Miguel Hidalgo - 11 560 México D.F.
<b>MOLDOVA</b>	<b>(22) 929249</b>	<b>2 ani</b> 2 years	ТОВ «Груп СЕБ Україна» 02121, Харківське шосе, 201-203, 3 поверх, Київ, Україна
<b>NEDERLAND The Netherlands</b>	<b>0318 58 24 24</b>	<b>2 jaar</b> 2 years	GRUPE SEB NEDERLAND BV De Schutterij 27 - 3905 PK Veenendaal - Nederland
<b>NEW ZEALAND</b>	<b>0800 700 711</b>	<b>1 year</b>	GRUPE SEB NEW ZEALAND Unit E, Building 3, 195 Main Highway, Ellerslie, Auckland
<b>NORGE NORWAY</b>	<b>815 09 567</b>	<b>2 år</b> 2 years	GRUPE SEB NORDIC AS Tempovej 27 - 2750 Ballerup
<b>PERU</b>	<b>441 4455</b>	<b>1 año</b> 1 year	Groupe SEB Perú Av. Camino Real N° 111 of. 805 B - San Isidro - Lima



			
<b>POLSKA POLAND</b>	<b>0801 300 423</b> koszt jak za połączenie lokalne	<b>2 lata</b> 2 years	GRUPE SEB POLSKA Sp. z o.o ul. Bukowińska 22b 02-703 Warszawa
<b>PORTUGAL</b>	<b>808 284 735</b>	<b>2 anos</b> 2 years	GRUPE SEB IBÉRICA SA Urb. da Matinha - Rua Projectada à Rua 3 Bloco1 - 3° B/D 1950 - 327 Lisboa
<b>REPUBLIC OF IRELAND</b>	<b>01 677 4003</b>	<b>1 year</b>	GRUPE SEB IRELAND Unit B3 Aerodrome Business Park, College Road, Rathcoole, Co. Dublin
<b>ROMÂNIA ROMANIA</b>	<b>0 21 316 87 84</b>	<b>2 ani</b> 2 years	GRUPE SEB ROMÂNIA Str. Daniel Constantin nr. 8 - 010632 Bucuresti
<b>РОССИЯ RUSSIA</b>	<b>495 213 32 29</b>	<b>2 года</b> 2 years	ЗАО «Группа СЕБ-Восток», 125171, Москва, Ленинградское шоссе, д. 16А, стр. 3
<b>SRBIJA SERBIA</b>	<b>060 0 732 000</b>	<b>2 godine</b> 2 years	SEB Development Đorđa Stanojevića 11b 11070 Novi Beograd
<b>SINGAPORE</b>	<b>6550 8900</b>	<b>1 year</b>	GRUPE SEB SINGAPORE Pty Ltd. 59 Jalan Pemimpin, #04-01/02 L&Y Building Singapore 577218
<b>SLOVENSKO SLOVAKIA</b>	<b>233 595 224</b>	<b>2 roky</b> 2 years	GRUPE SEB SLOVENSKO spol. s r.o. Rybničná 40 - 831 06 Bratislava
<b>SLOVENIJA SLOVENIA</b>	<b>02 234 94 90</b>	<b>2 leti</b> 2 years	SEB d.o.o Gregorčičeva ulica 6 - 2000 MARIBOR
<b>ESPAÑA SPAIN</b>	<b>902 31 22 00</b>	<b>2 años</b> 2 years	GRUPE SEB IBÉRICA S.A. C/ Almogàvers, 119-123, Complejo Ecourban 08018 Barcelona
<b>SVERIGE SWEDEN</b>	<b>08 594 213 30</b>	<b>2 år</b> 2 years	TEFAL SVERIGE SUBSIDIARY OF GROUP SEB NORDIC Truckvägen 14 A, 194 52 Upplands - Väsby
<b>SUISSE / SCHWEIZ SWITZERLAND</b>	<b>044 837 18 40</b>	<b>2 ans</b> <b>2 Jahre</b> 2 years	GRUPE SEB SCHWEIZ GmbH Thurgauerstrasse 105 8152 Glattbrugg
<b>台灣 TAIWAN</b>	<b>02 28333716</b>	<b>1 year</b>	SEB ASIA Ltd. Taiwan Branch 4F., No. 37 Dexing W. Rd., Shilin Dist., Taipei City 11158, Taiwan (R.O.C.)
<b>ประเทศไทย THAILAND</b>	<b>02 769 7477</b>	<b>2 years</b>	GRUPE SEB THAILAND 2034/66 1althai Tower, 14th Floor, n° 14-02, New Phetchburi Road, Bangkapi, Huaykwang, Bangkok, 10320
<b>TÜRKIYE TURKEY</b>	<b>216 444 40 50</b>	<b>2 YIL</b> 2 years	GRUPE SEB ISTANBUL AS Beybi Giz Plaza Dereboyu Cad. - Meydan Sok. No: 28 K.12 Masiak
<b>U.S.A.</b>	<b>800-395-8325</b>	<b>1 year</b>	GRUPE SEB USA 2121 Eden Road - Millville, NJ 08332
<b>УКРАЇНА UKRAINE</b>	<b>044 300 13 04</b>		ТОВ «Грун СЕБ Україна» 02121, Харківське шосе, 201-203, 3 поверх, Київ, Україна
<b>UNITED KINGDOM</b>	<b>0845 602 1454</b>	<b>1 year</b>	GRUPE SEB UK LTD Riverside House, Riverside Walk Windsor, Berkshire, SL4 1NA
<b>VENEZUELA</b>	<b>0800-7268724</b>	<b>2 años</b> 2 year	GRUPE SEB VENEZUELA Av Eugenio Mendoza, Centro Letonia, Torre ING Bank, Piso 15, Ofc 155 - Urb. La Castellana, Caracas
<b>VIETNAM</b>	<b>08 38645830</b>	<b>1 year</b>	Vietnam Fan Joint Stock Company 25 Nguyen Thi Nho Str, Ward 9, Tan Binh Dist, HCM city

## **MOULINEX INTERNATIONAL GUARANTEE**

**Date of purchase:** ..... / Date d'achat / Fecha de compra / Data da compra / Data d'acquisto / Kaufdatum / Aankoopdatum / Købsdato / Inköpsdatum / Kjøpsdato / Ostopäivä / Data zakupu / Data vânzării / [sigijimo data/ Ostukuupäev / Datum nakupa / Sorozatszám / Dátum nákupu / Pirkuma datums / Datum Kupovine / Datum kupnje / Data cumpărării / Datum nákupu / Tarikh pembelian / Tanggal pembelian / Ngày mua hàng / Satın alma tarihi / Дата прџдажи / Дата на закупуване / Датум на купување / Сатылган мерзімі / Ημερομηνία αγοράς / Վեճմանքի օրը / วันทีซ้อ / 購買日期 / 購入日 / 구입일자 / تاريخ الشراء / خرید تاريخ

**Product reference:** ..... / Référence du produit / Referencia del producto / Referência do produto / tipo de prodotto / Typnummer des Gerätes / Artikelnummer van het apparaat / Referencenummer / Produktreferens / Artikelnummer / Tuotenumero / referencia produktu / Model / Gaminio numeris / Toote viitenumber / Tip aparata / Vásárlás kelte / Typ výrobu / Produkta atsauces numurs / Model proizvoda / Oznaka proizvoda / Cod produs / Produk rujukan / Referensi produk / Mã sản phẩm/ Ürün kodu / Мпдель / Мпдель / Мпдел на уреда / Мпдели / Κωδικός προϊόντος / Униқі / วันผลิตถึถึถึ / 產品模型 / 製品レフアレンス番号/제품명 / مرجع كامل محصول / مرجع المنتَج الكامل

**Retailer name & address:** ..... / Nom et adresse du vendeur / Nombre y dirección del minorista / Nome e endereço do revendedor / Nome e indirizzo delnegozio / Name und Anschrift des Händlers / Naam en adres van de dealer / Forhandler navn & adresse / Återförsäljarens namn och adress / Forhandler navn og adresse / Jälleenmyyjän nimi ja osoite / nazwa i adres sprzedawcy / Numele și adresa vânzătorului / Parduotuvės pavadinimas ir adresas / Müüja kauplus ja aadress / Naziv in naslov trgovine / Tipusszám / Názov a adresa predajcu / Veikala nosaukums un adrese / Naziv i adresa maloprodaje / Naziv i adresa prodavca / Naziv i adresa prodajnog mjesta / Nume și adresă vânzător / Název a adresa prodejece / Nama dan alamat peruncit / Nama Toko Penjual dan alamat / Tên và địa chỉ cửa hàng bán/ Satıcı firmanın adı ve adresi / Название и адрес прџдавца / Назва i adresa прџдавця / Търговски пбект / Назив и адреса на прџдавницата / Сатушының аты және мекен-жайы / Επωνυμία και διεύθυνση καφαζήτηματος / Վեճմանքի սեղմանքը և հասցեն / ชื่อและที่อยู่ของห้าง/ร้านทีซ้อ / 零售商的店名和地址/販売店の名前、住所/소매점 이름과 주소/ نام و آدرس خرده فروش / اسم وعنوان بائع التجزئة

**Distributor stamp** ..... Cachet distributeur / Sello del distribuidor / Carimbo do revendedor / Timbro del negozio / Händlerstempel / Stempel van de dealer / Forhandler stempel / Återförsäljarens stämpel / Forhandler stempel / Jälleenmyyjän leima / pieczęć sprzedawcy / Ştampila vânzătorului / Antspaudas / Tempel / Žig trgovine / Eladó neve, címe/ Razítko predajcu / Zīmogs / Pečat maloprodaje/ Pečat prodavca / Pečat prodajnog mjesta / Ştampila vânzătorului/ Razítko prodejece/ Cap peruncit / Cap dari Toko Penjual / Cửa hàng bán đồng dấu/ Satıcı Firmanın Kaşesi / Печать прџдавца / Печатка прџдавця / Печат на търговския пбект / Печат на прџдавницата / Сатушының мөрі / Σθραγίδα καφαζήτηματος / Վեճմանքի հիգիբը / ตราประทับของห้าง/ร้านทีซ้อ / 零售商的蓋印 / 販売店印 / 소매점 직인 / فروش مهر خرده / ختم بائع التجزئة

**Moulinex**<sup>®</sup>  
mega 2kg