























MARQUE: MOULINEX

REFERENCE: DJ305110 MOULINETTE

CODIC: 4103483





		
	100g	6 
	80/100g	5 
	100g	8 
	15g	5 
	50g	15s
	40g	8 
 <p>2x2 cm</p>	40g	15s
	20g	10s
 <p>2x2 cm</p>	80/100g	10s
	200g	20s
	200g	20s
	2 	5 

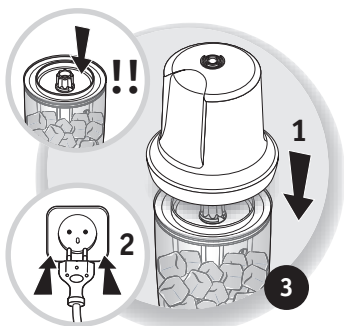
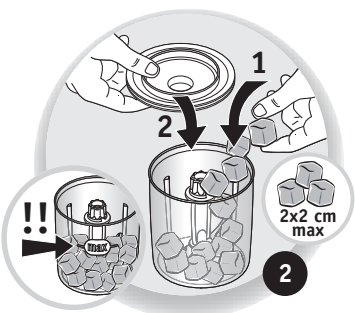
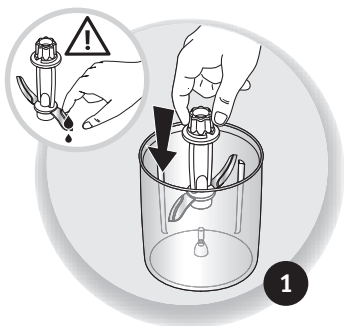
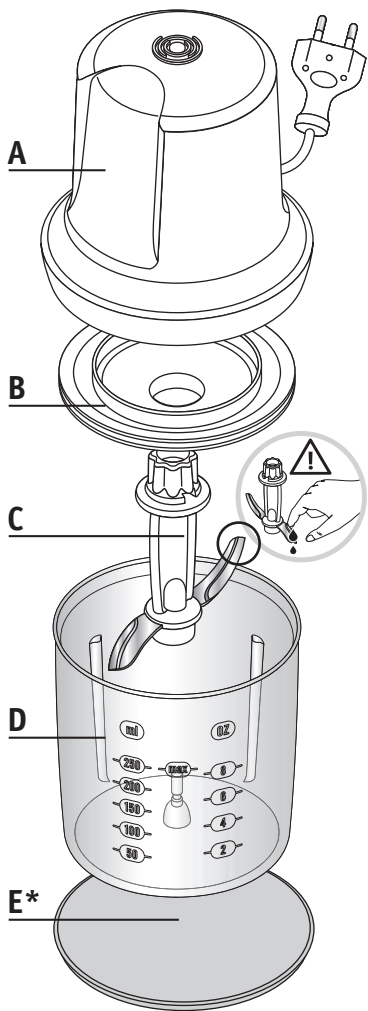

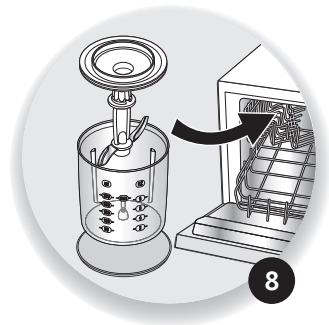
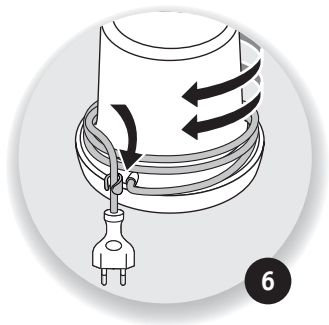
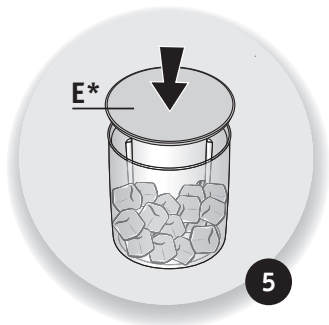

DESCRIPTION

A - Bloc moteur

B - Coupelle d'étanchéité

C - Couteau

D - Bol en plastique

E* - Base antidérapante et couvercle
(selon modèle)

UTILISATION (cf. fig.1 à fig.5)

CONSEILS D'UTILISATION

Manipulez le couteau avec précaution car les lames sont très coupantes.

Ne faites pas tourner l'appareil à vide.





Préparations semi-liquides : ne pas dépasser le niveau maxi du bol. **Conseils pour obtenir de bons résultats :** Travaillez en impulsions. Si les morceaux d'aliments restent collés sur la paroi du bol (jambon, oignons...), décollez les morceaux à l'aide d'une spatule, répartissez-les dans le bol et effectuez 2 ou 3 impulsions supplémentaires.

RANGEMENT DU CORDON (cf. fig.6)

NETTOYAGE DE L'APPAREIL (cf. fig.7 à fig.8)

INTERNATIONAL GUARANTEE : COUNTRY LIST



			
الجزائر ALGERIA	(0)41 28 18 53	سنة واحدة 1 year	CIJA 9 rue Puvis de Chavannes Saint Euquene Oran
ARGENTINA	0800-122-2732	2 años 2 years	GRUPE SEB ARGENTINA S.A. Billinghurst 1833 3° C1425DTK Capital Federal Buenos Aires
ՀԱՅԱՍՏԱՆ ARMENIA	(010) 55-76-07	2 տարի 2 years	ՓԲԸ "Գրուպա ՄԵՐ", 125171, Մոսկվա, Լենինգրադյան խճուղի, 16A, շին.3
AUSTRALIA	02 97487944	2 years	GRUPE SEB AUSTRALIA PO Box 7535, Silverwater NSW 2128
ÖSTERREICH AUSTRIA	01 866 70 299 00	2 Jahre 2 years	SEB ÖSTERREICH GmbH Campus 21 - Businesspark Wien Süd, Liebermannstr. A02 702 2345 Brunn am Gebirge
БЕЛАРУСЬ BELARUS	017 2239290	2 года 2 years	ЗАО «Группа СЕБ-Восток», 125171, Москва, Ленинградское шоссе, д. 16А, стр. 3
BELGIQUE BELGIE BELGIUM	070 23 31 59	2 ans 2 years	GRUPE SEB BELGIUM SA NV 25 avenue de l'Espérance - ZI 6220 Fleurus
BOSNA I HERCEGOVINA	Info-linija za potrošače 033 551 220	2 godine 2 years	SEB Développement Predstavništvo u BiH Vrazova 8/II 71000 Sarajevo
BRASIL BRAZIL	0800-119933	1 ano 1 year	SEB COMERCIAL DE PRODUTOS DOMÉSTICOS LTDA Rua Venâncio Aires, 433/437/447, Pompéia, São Paulo/SP
БЪЛГАРИЯ BULGARIA	0700 10 330	2 години 2 years	ГРУП СЕБ БЪЛГАРИЯ ЕООД бул. България 81 В, ет. 5 1404 София
CANADA	1-800-418-3325	1 an 1 year	GRUPE SEB CANADA 345 Passmore Avenue Toronto, ON, M1V 3N8
CHILE	12300 209207	2 años 2 years	GRUPE SEB CHILE Comercial Ltda Av. Providencia, 2331, Piso 5, Oficina 501 Santiago
COLOMBIA	18000919288	2 años 2 years	GRUPE SEB COLOMBIA Apartado Aereo 172, Kilometro 1 Via Zipaquira, Cajica Cundinamarca
HRVATSKA CROATIA	01 30 15 294	2 godine 2 years	SEB Développement S.A.S. Vodnjanska 26, 10000 Zagreb
ČESKÁ REPUBLIK CZECH REPUBLIC	731 010 111	2 roky 2 years	GRUPE SEB ČR spol. s r. o. Jankovcova 1569/2c 170 00 Praha 7

DANMARK DENMARK	44 663 155	2 ár 2 years	GRUPE SEB NORDIC AS Tempovej 27, 2750 Ballerup
EESTI ESTONIA	5 800 3777	2 aastat 2 years	GRUPE SEB POLSKA Sp. z o.o. ul. Bukowińska 22b 02-703 Warszawa
مصر EGYPT	الخط الساخن: 16622	سنة واحدة 1 year	جروب سب ايجيبت طريق 14 مايو - سموحة الإسكندرية - مصر
SUOMI FINLAND	09 622 94 20	2 vuotta 2 years	Groupe SEB Finland Kutojantie 7, 02630 Espoo
FRANCE Continentale + Guadeloupe, Martinique, Réunion, Saint-Martin	09 74 50 47 74	1 an 1 year	GRUPE SEB FRANCE Service Consommateur Tefal BP 15 69131 ECULLY CEDEX
DEUTSCHLAND GERMANY	0212 387 400	2 Jahre 2 years	GRUPE SEB DEUTSCHLAND GmbH / KRUPS GmbH Herrnrainweg 5, 63067 Offenbach
ΕΛΛΑΔΑ GREECE	2106371251	2 χρόνια 2 years	SEB GROUPE ΕΛΛΑΔΟΣ Α.Ε. Οδός Καβαλιεράτου 7 Τ.Κ. 145 64 Κ. Κηφισιά
香港 HONG KONG	8130 8998	1 year	SEB ASIA Ltd. Room 903, 9/F, South Block, Skyway House 3 Sham Mong Road, Tai Kok Tsui, Kowloon, Hong-Kong
MAGYARORSZÁG HUNGARY	06 1 801 8434	2 év 2 years	GRUPE SEB CENTRAL EUROPE Kft. Táviró köz 4 2040 Budaörs
INDONESIA	+62 21 5793 6881	1 year	GRUPE SEB INDONESIA (Representative office) Sudirman Plaza, Plaza Marein 8th Floor JL Jendral Sudirman Kav 76-78, Jakarta 12910, Indonesia
ITALIA ITALY	199207354	2 anni 2 years	GRUPE SEB ITALIA S.p.A. Via Montefeltro, 4 20156 Milano
日本 JAPAN	0570 077 772	1 year	株式会社グループセブジャパン 〒141-0022 東京都品川区東五反田 3-14-13 高輪ミュージズビル
ҚАЗАҚСТАН KAZAKHSTAN	727 378 39 39	2 жыл 2 years	ЖАҚ «Группа СЕБ- Восток» 125171, Мәскеу, Ленинградское шоссесі, 16А, 3 үйі
한국어 KOREA	1588-1588	1 year	(유)그룹 세브 코리아 서울시 종로구 서린동 88 서린빌딩 3층, 110-790
LATVJA LATVIA	6 716 2007	2 gadi 2 years	GRUPE SEB POLSKA Sp. z o.o. ul. Bukowińska 22b, 02-703 Warszawa

LIETUVA LITHUANIA	6 470 8888	2 metai 2 years	GRUPE SEB POLSKA Sp. z o.o. ul. Bukowińska 22b, 02-703 Warszawa
LUXEMBOURG	0032 70 23 31 59	2 ans 2 years	GRUPE SEB BELGIUM SA NV 25 avenue de l'Espérance - ZI 6220 Fleurus
МАКЕДОНИЈА MACEDONIA	(0)2 20 50 022	2 години 2 years	Groupe SEB Bulgaria EOOD Office 1, floor 1, 52G Borovo St., 1680 Sofia - Bulgaria ГРУП СЕБ БЪЛГАРИЯ ДООЕЛ Ул. Борово 52 Г, сп. 1, офис 1, 1680 София, България
MALAYSIA	603 7710 1175	2 years	GRUPE SEB MALAYSIA SDN. BHD Unit No. 402-403, Level 4, Uptown 2, No. 2, Jalan SS21/37, Damansara Uptown, 47400, Petaling Jaya, Selangor D.E. Malaysia
MEXICO	(01800) 112 8325	1 año 1 year	Groupe S.E.B. México, S.A. DE C.V. Goldsmith 38 Desp. 401, Col. Polanco Delegación Miguel Hildalgo 11 560 México D.F.
MOLDOVA	(22) 929249	2 ani 2 years	ТОВ «Груп СЕБ Україна» 02121, Харківське шосе, 201-203, 3 поверх, Київ, Україна
NEDERLAND The Netherlands	0318 58 24 24	2 jaar 2 years	GRUPE SEB NEDERLAND B.V. De Schutterij 27 3905 PK Veenendaal
NEW ZEALAND	0800 700 711	1 year	GRUPE SEB NEW ZEALAND Unit E, Building 3, 195 Main Highway, Ellerslie, Auckland
NORGE NORWAY	815 09 567	2 år 2 years	GRUPE SEB NORDIC AS Tempovej 27 2750 Ballerup
PERU	441 4455	1 año 1 year	Groupe SEB Perú Av. Camino Real N° 111 of. 805 B San Isidro - Lima
POLSKA POLAND	0801 300 421 koszt jak za połączenie lokalne	2 lata 2 years	GRUPE SEB POLSKA Sp. z o.o. ul. Bukowińska 22b, 02-703 Warszawa
PORTUGAL	808 284 735	2 anos 2 years	GRUPE SEB IBÉRICA SA Urb. da Matinha Rua Projectada à Rua 3 Bloco1 - 3º B/D 1950 - 327 Lisboa
REPUBLIC OF IRELAND	01 677 4003	1 year	GRUPE SEB IRELAND Unit B3 Aerodrome Business Park, College Road, Rathcoole, Co. Dublin
ROMÂNIA ROMANIA	0 21 316 87 84	2 ani 2 years	GRUPE SEB ROMÂNIA Str. Daniel Constantin nr. 8 010632 București

РОССИЯ RUSSIA	495 213 32 30	2 года 2 years	ЗАО «Группа СЕБ-Восток», 125171, Москва, Ленинградское шоссе, д. 16А, стр. 3
SRBIJA SERBIA	060 0 732 000	2 godine 2 years	SEB Developpement Đorđa Stanojevića 11b 11070 Novi Beograd
SINGAPORE	6550 8900	1 year	ГROUPE SEB SINGAPORE Pty Ltd. 59 Jalan Pemimpin, #04-01/02 L&Y Building, Singapore 577218
SLOVENSKO SLOVAKIA	233 595 224	2 roky 2 years	ГROUPE SEB Slovensko, spol. s r.o. Rybničná 40, 831 06 Bratislava
SLOVENIJA SLOVENIA	02 234 94 90	2 leti 2 years	SEB d.o.o Gregorčičeva ulica 6 2000 MARIBOR
ESPAÑA SPAIN	902 31 24 00	2 años 2 years	ГROUPE SEB IBÉRICA S.A. C/ Almogàvers, 119-123, Complejo Ecourban, 08018 Barcelona
SVERIGE SWEDEN	08 594 213 30	2 år 2 years	TEFAL SVERIGE SUBSIDIARY OF ГROUPE SEB NORDIC Truckvägen 14 A, 194 52 Upplands Väsby
SUISSE SCHWEIZ SWITZERLAND	044 837 18 40	2 ans 2 Jahre 2 years	ГROUPE SEB SCHWEIZ GmbH Thurgauerstrasse 105 8152 Glattbrugg
台灣 TAIWAN	02 28333716	1 year	SEB ASIA Ltd. Taiwan Branch 4F., No. 37 Dexing W. Rd., Shilin Dist., Taipei City 11158, Taiwan (R.O.C.)
ประเทศไทย THAILAND	02 769 7477	2 years	ГROUPE SEB THAILAND 2034/66 Italthai Tower, 14th Floor, n° 14-02, New Phetchburi Road, Bangkapi, Huaykwang, Bangkok, 10320
TÜRKIYE TURKEY	216 444 40 50	2 YIL 2 years	ГROUPE SEB ISTANBUL AS Beybi Giz Plaza Dereboyu Cad. Meydan Sok., No: 28 K.12 Maslak
U.S.A.	800-395-8325	1 year	ГROUPE SEB USA 2121 Eden Road, Millville, NJ 08332
Україна UKRAINE	044 300 13 04	2 роки 2 years	ТОВ «Груп СЕБ Україна» 02121, Харківське шосе, 201-203, 3 поверх, Київ, Україна
UNITED KINGDOM	0845 602 1454	1 year	ГROUPE SEB UK LTD Riverside House, Riverside Walk Windsor, Berkshire, SL4 1NA
VENEZUELA	0800-7268724	2 años 2 years	ГROUPE SEB VENEZUELA Av Eugenio Mendoza, Centro Letonia, Torre ING Bank, Piso 15, Ofc 155 Urb. La Castellana, Caracas
VIETNAM	08 38645830	2 years	Vietnam Fan Joint Stock Company 25 Nguyen Thi Nho Str, Ward 9, Tan Binh Dist, HCM city

INTERNATIONAL GUARANTEE

Date of purchase: / Date d'achat / Fecha de compra / Data da compra / Data d'acquisto / Kaufdatum / Aankoopdatum / Købsdato / Inköpsdatum / Kjøpsdato / Ostopäivä / Data zakupu / Data vânzării / Įsigijimo data/ Ostukuupäev / Datum nakupa / Sorozatszám / Dátum nákupu / Pirkuma datums / Datum Kupovine/ Datum kupnje / Data cumpărării / Datum nákupu / Tarikh pembelian / Tanggal pembelian / Ngày mua hàng / Satin alma tarihi / Дата продажи / Дата на закупуване / Датум на купување / Сатылган мерзімі / Ημερομηνία αγοράς / Ψαδωπηρή ορη / ദൃശ്ശീകരണം / 購買日期 / 購入日 / 구입일자 / تاريخ الشراء / تاريخ خري

Product reference: / Référence du produit / Referencia del producto / Nome do produto / Tipo de prodotto / Typnummer des Gerätes / Artikelnummer van het apparaat / Referencenummer / Produktreferens / Artikkelnummer / Tuotenumero / referenčija produktu / Model / Gaminio numeris / Toote viitenumber / Tip aparata / Vásárlás kelte / Typ výrobku / Produkta atsauces numurs / Model proizvodna / Oznaka proizvoda / Cod produs / Produk rujukan / Referensi produk / Mã sản phẩm/ Ürün kodu / Модель / Модель / Модел на уреда / Модели / Κωδικός προϊόντος / Ὑψηλὴ / දුබලිකරණය / 產品模型 / 製品番号 / 제품명 / مرجع المنتج الكامل / مرجع كامل محصول

Retailer name & address: / Nom et adresse du vendeur / Nombre y dirección del minorista / Nome e endereço do revendedor / Nome e indirizzo del negozio / Name und Anschrift des Händlers / Naam en adres van de dealer / Forhandler navn & adresse / Återförsäljarens namn och adress / Forhandler navn og adresse / Jälleenmyyjän nimi ja osoite / nazwa i adres sprzedawcy / Numele și adresa vânzătorului / Parduotuvės pavadinimas ir adresas / Müüja kauplus ja aadress / Naziv in naslov trgovine / Tipusszám / Názov a adresa predajcu / Veikala nosaukums un adrese / Naziv i adresa maloprodaje / Naziv i adresa prodavca / Naziv i adresa prodajnog mjesta / Nume și adresă vânzător / Název a adresa prodejece / Nama dan alamat peruncit / Nama Toko Penjual dan alamat / Tên và địa chỉ cửa hàng bán/ Satıcı firmanın adı ve adresi / Название и адрес продавца / Назва і адреса продавця / Търговски обект / Назив и адреса на продавницата / Сатушының аты және мекен-жайы / Επωνυμία και διεύθυνση καταστήματος / Ψαδωπηρή ή υπάλληλος ή huuglú / ชื่อและที่อยู่ของห้าง/ร้านที่ซื้อ / 零售商的店名和地址 / 販売店名、住所 / 소매점 이름과 주소 / عنوانه / نام درس خرده فروش / اوا اسم بائع التجزئة و عنوانه

Distributor stamp / Cachet distributeur / Sello del distribuidor / Carimbo do revendedor / Timbro del negozio / Händlerstempel / Stempel van de dealer / Forhandler stempel / Återförsäljarens stämpel / Forhandler stempel / Jälleenmyyjän leima / pieczęć sprzedawcy / Štampila vânzătorului / Antspaudas / Tempel / Žig trgovine / Eladó neve, címe/ Razítko predajcu / Zímogs / Pečat maloprodaje/ Pečat prodavca / Pečat prodajnog mjesta / Štampila vânzătorului/ Razítko prodejece/ Cap peruncit / Cap dari Toko Penjual / Cửa hàng bán đóng dấu/ Satıcı Firmanın Kaşesi / Печать продавца / Печатка продавца / Печат на търговския обект / Печат на продавницата / Сатушының мөрі / Σφραγίδα καταστήματος / Ψαδωπηρή ή ύψλληρ / مهر خرده / ختم بائع التجزئة / 販売店印 / 販売店印 / 소매점 직인 / ختم بائع التجزئة / فرو